



# Application Note: AN\_SY8120B

## High Efficiency Fast Response, 2A, 18V Input Synchronous Step Down Regulator *Preliminary Specification*

### General Description

SY8120B develops high efficiency synchronous step-down DC-DC converter capable of delivering 2A load current. SY8120B operates over a wide input voltage range from 4.5V to 18V and integrates main switch and synchronous switch with very low  $R_{DS(ON)}$  to minimize the conduction loss.

SY8120B adopts the instant PWM architecture to achieve fast transient responses for high step down applications and high efficiency at light loads. In addition, it operates under heavy load conditions to minimize the size of inductor and capacitor.

### Ordering Information

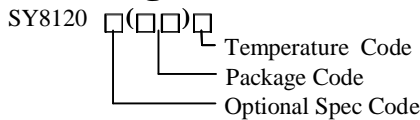

Temperature Range: -40°C to 85°C

Ordering Number	Package type	Note
SY8120BABC	SOT23-6	--

### Features

- Low  $R_{DS(ON)}$  for internal switches (top/bottom):145/135 mΩ
- 4.5-18V input voltage range
- 2A load current capability
- Instant PWM architecture to achieve fast transient responses Internal softstart limits the inrush current
- 2% 0.6V reference
- RoHS Compliant and Halogen Free
- Compact package: SOT23-6

### Applications

- Set Top Box
- Portable TV
- Access Point Router
- DSL Modem
- LCD TV

### Typical Applications

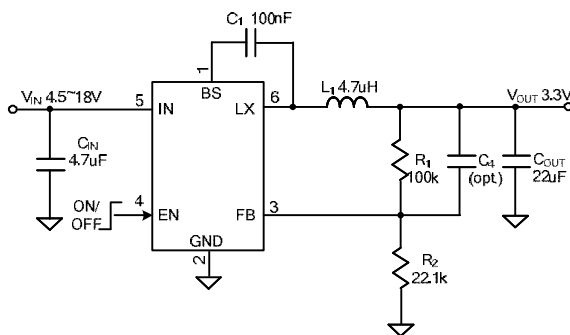

Figure 1. Schematic Diagram

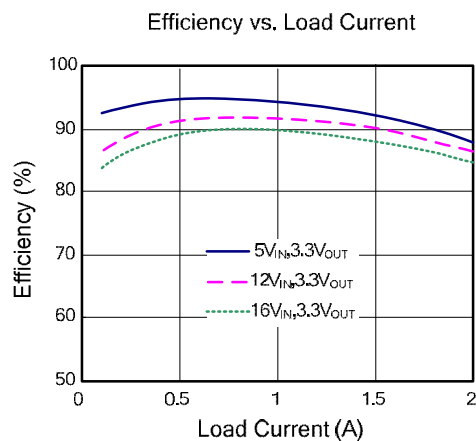
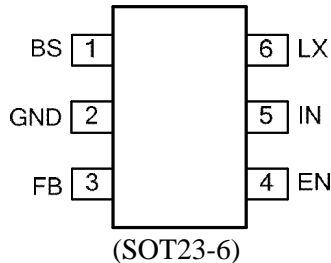

Figure 2. Efficiency Figure



## AN\_SY8120B

### Pinout (top view)



Top Mark: **NBxyz**, (Device code: NB, *x*=year code, *y*=week code, *z*=lot number code)

Pin Name	Pin Number	Pin Description
BS	1	Boot-Strap Pin. Supply high side gate driver. Decouple this pin to LX pin with 0.1uF ceramic cap.
GND	2	Ground pin
FB	3	Output Feedback Pin. Connect this pin to the center point of the output resistor divider (as shown in Figure 1) to program the output voltage: $V_{out}=0.6*(1+R1/R2)$
EN	4	Enable control. Pull high to turn on. Do not float.
IN	5	Input pin. Decouple this pin to GND pin with at least 1uF ceramic cap
LX	6	Inductor pin. Connect this pin to the switching node of inductor

### Absolute Maximum Ratings (Note 1)

Supply Input Voltage	19V
LX, EN Voltage	$V_{IN} + 0.3V$
FB, BS-LX Voltage	4V
Power Dissipation, $P_D$ @ $T_A = 25^\circ C$ SOT23-6,	0.6W
Package Thermal Resistance (Note 2)	
$\theta_{JA}$	170°C/W
$\theta_{JC}$	130°C/W
Junction Temperature Range	125°C
Lead Temperature (Soldering, 10 sec.)	260°C
Storage Temperature Range	-65°C to 150°C

### Recommended Operating Conditions (Note 3)

Supply Input Voltage	4.5V to 18V
Junction Temperature Range	-40°C to 125°C
Ambient Temperature Range	-40°C to 85°C



## AN\_SY8120B

### Electrical Characteristics

( $V_{IN} = 12V$ ,  $V_{OUT} = 1.2V$ ,  $L = 2.2\mu H$ ,  $C_{OUT} = 10\mu F$ ,  $T_A = 25^\circ C$ ,  $I_{OUT} = 1A$  unless otherwise specified)

Parameter	Symbol	Test Conditions	Min	Typ	Max	Unit
Input Voltage Range	$V_{IN}$		4.5		18	V
Quiescent Current	$I_Q$	$I_{OUT}=0$ , $V_{FB}=V_{REF}\times 105\%$		400		$\mu A$
Shutdown Current	$I_{SHDN}$	EN=0		5	10	$\mu A$
Feedback Reference Voltage	$V_{REF}$		0.588	0.6	0.612	V
FB Input Current	$I_{FB}$	$V_{FB}=V_{IN}$	-50		50	nA
Top FET RON	$R_{DS(ON)1}$			0.145		$\Omega$
Bottom FET RON	$R_{DS(ON)2}$			0.135		$\Omega$
Bottom FET Valley Current Limit	$I_{LIM}$		2			A
EN Rising Threshold	$V_{ENH}$		1.5			V
EN Falling Threshold	$V_{ENL}$				0.4	V
Input UVLO Threshold	$V_{UVLO}$				4.5	V
On Time	$T_{ON}$	$V_{IN} = 12V, V_{OUT}=1.2V, I_{OUT} = 1A$		200		ns
Min ON Time				50		ns
Min Off Time				100		ns
Thermal Shutdown Temperature	$T_{SD}$			150		$^\circ C$
Thermal Shutdown Hysteresis	$T_{HYS}$			15		$^\circ C$

**Note 1:** Stresses listed as the above “Absolute Maximum Ratings” may cause permanent damage to the device. These are for stress ratings. Functional operation of the device at these or any other conditions beyond those indicated in the operational sections of the specifications is not implied. Exposure to absolute maximum rating conditions for extended periods may remain possibility to affect device reliability.

**Note 2:**  $\theta_{JA}$  is measured in the natural convection at  $T_A = 25^\circ C$  on a low effective single layer thermal conductivity test board of JEDEC 51-3 thermal measurement standard. Pin 2 of SOT-23-6 packages is the case position for  $\theta_{JC}$  measurement.

**Note 3:** The device is not guaranteed to function outside its operating conditions.



# AN\_SY8120B

## Typical Performance Characteristics

Efficiency vs. Load Current

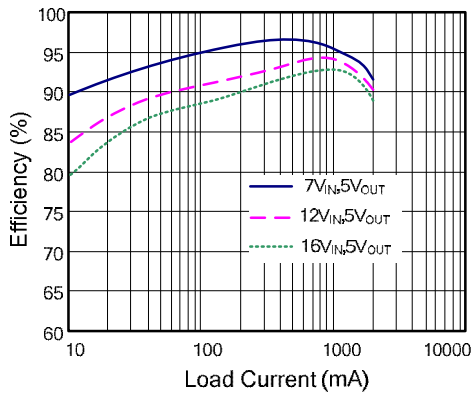

Efficiency vs. Load Current

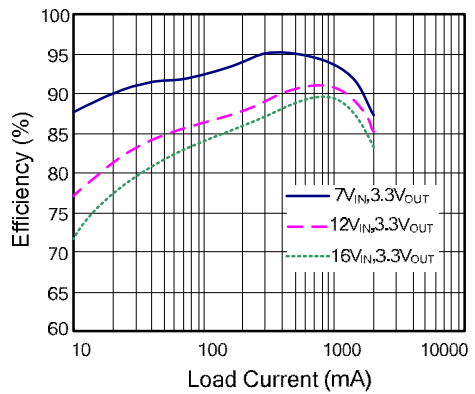

Efficiency vs. Load Current

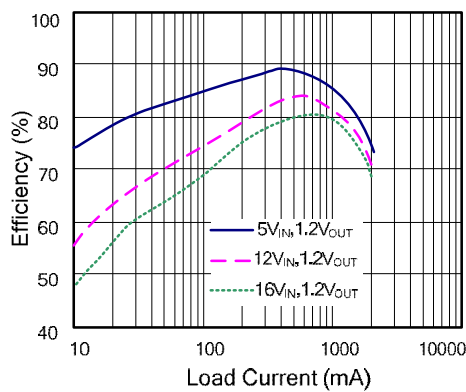

Output Ripple

(VIN=12V, VOUT=3.3V, ILOAD=2A)

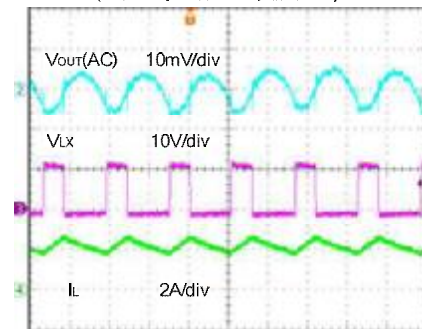

Load Transient

(VIN=12V, VOUT=3.3V, ILOAD=0.2-1A)

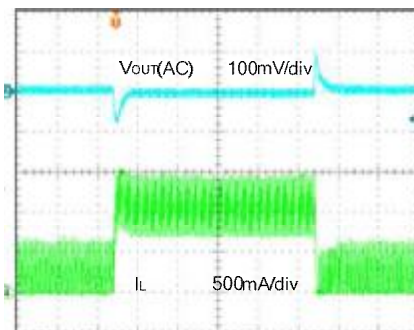

Load Transient

(VIN=12V, VOUT=3.3V, ILOAD=1-2A)

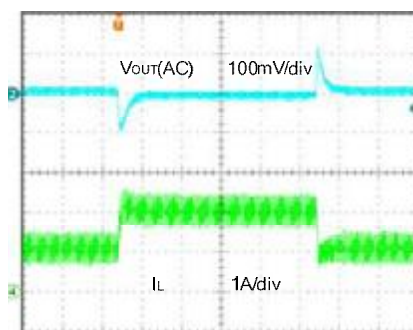



## AN\_SY8120B

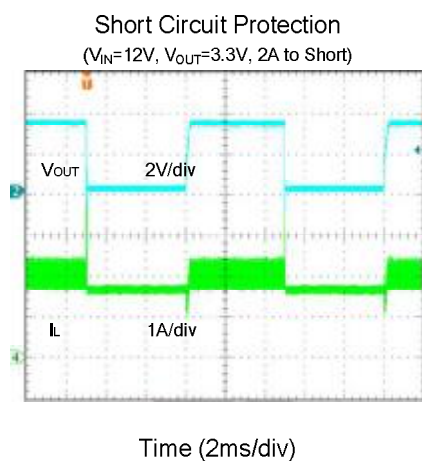
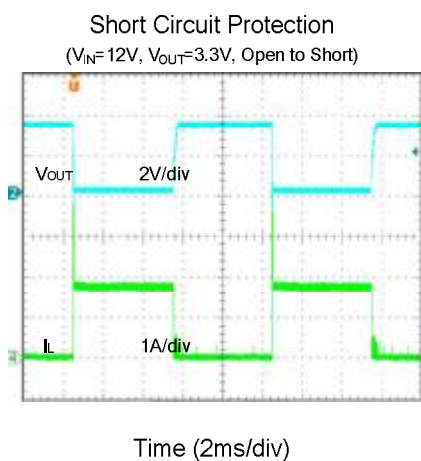
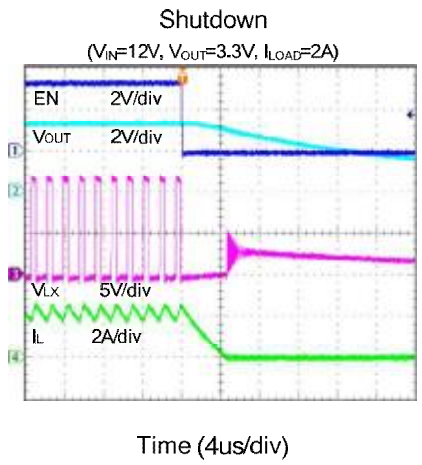
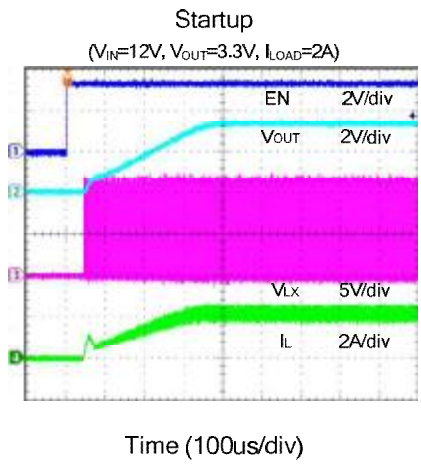



## AN\_SY8120B

### Operation

SY8120B is a synchronous buck regulator IC that integrates the PWM control, top and bottom switches on the same die to minimize the switching transition loss and conduction loss. With ultra low Rds(on) power switches and proprietary PWM control, this regulator IC can achieve the highest efficiency and the highest switch frequency simultaneously to minimize the external inductor and capacitor size, and thus achieving the minimum solution footprint.

SY8120B provides protection functions such as cycle by cycle current limiting and thermal shutdown protection. SY8120B will sense the output voltage conditions for the fault protection.

### Applications Information

Because of the high integration in the SY8120B IC, the application circuit based on this regulator IC is rather simple. Only input capacitor C<sub>IN</sub>, output capacitor C<sub>OUT</sub>, output inductor L and feedback resistors (R<sub>1</sub> and R<sub>2</sub>) need to be selected for the targeted applications specifications.

#### Feedback resistor dividers R<sub>1</sub> and R<sub>2</sub>:

Choose R<sub>1</sub> and R<sub>2</sub> to program the proper output voltage. To minimize the power consumption under light loads, it is desirable to choose large resistance values for both R<sub>1</sub> and R<sub>2</sub>. A value of between 10kΩ and 1MΩ is highly recommended for both resistors. If V<sub>out</sub> is 3.3V, R<sub>1</sub>=100k is chosen, then using following equation, R<sub>2</sub> can be calculated to be 22.1k:

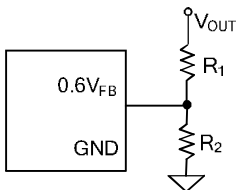
$$R_2 = \frac{0.6V}{V_{OUT} - 0.6V} R_1$$

#### Input capacitor C<sub>IN</sub>:

The ripple current through input capacitor is calculated as:

$$I_{CIN\_RMS} = I_{OUT} \cdot \sqrt{D(1-D)}$$

To minimize the potential noise problem, place a typical X5R or better grade ceramic capacitor really close to the IN and GND pins. Care should be taken to

minimize the loop area formed by C<sub>IN</sub>, and IN/GND pins. In this case, a 4.7uF low ESR ceramic capacitor is recommended.

#### Output capacitor C<sub>OUT</sub>:

The output capacitor is selected to handle the output ripple noise requirements. Both steady state ripple and transient requirements must be taken into consideration when selecting this capacitor. For the best performance, it is recommended to use X5R or better grade ceramic capacitor greater than 22uF capacitance.

#### Output inductor L:

There are several considerations in choosing this inductor.

- 1) Choose the inductance to provide the desired ripple current. It is suggested to choose the ripple current to be about 40% of the maximum output current. The inductance is calculated as:

$$L = \frac{V_{OUT}(1 - V_{OUT}/V_{IN,MAX})}{F_{SW} \times I_{OUT,MAX} \times 40\%}$$

where F<sub>sw</sub> is the switching frequency and I<sub>OUT,MAX</sub> is the maximum load current.

The SY8120B regulator IC is quite tolerant of different ripple current amplitude. Consequently, the final choice of inductance can be slightly off the calculation value without significantly impacting the performance.

- 2) The saturation current rating of the inductor must be selected to be greater than the peak inductor current under full load conditions.

$$I_{SAT, MIN} > I_{OUT, MAX} + \frac{V_{OUT}(1 - V_{OUT}/V_{IN,MAX})}{2 \cdot F_{SW} \cdot L}$$

- 3) The DCR of the inductor and the core loss at the switching frequency must be low enough to achieve the desired efficiency requirement. It is desirable to choose an inductor with DCR < 50mΩ to achieve a good overall efficiency.

#### External Bootstrap Cap

This capacitor provides the gate driver voltage for internal high side MOSEFET. A 100nF low ESR ceramic capacitor connected between BS pin and LX pin is recommended.

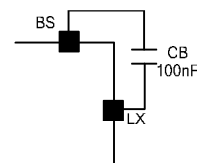



## AN\_SY8120B

### Load Transient Considerations:

The SY8120B regulator IC integrates the compensation components to achieve good stability and fast transient responses. In some applications, adding a 22pF ceramic cap in parallel with R1 may further speed up the load transient responses and is thus recommended for applications with large load transient step requirements.

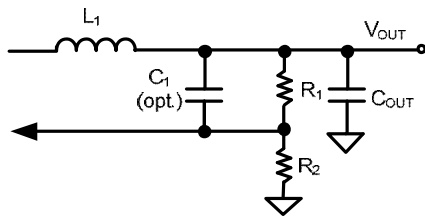

### Layout Design:

The layout design of SY8120B regulator is relatively simple. For the best efficiency and minimum noise problem, we should place the following components close to the IC:  $C_{IN}$ , L,  $R_1$  and  $R_2$ .

1) It is desirable to maximize the PCB copper area connecting to GND pin to achieve the best thermal and noise performance. If the board space allowed, a ground plane is highly desirable.

2)  $C_{IN}$  must be close to Pins IN and GND. The loop area formed by  $C_{IN}$  and GND must be minimized.

3) The PCB copper area associated with LX pin must be minimized to avoid the potential noise problem.

4) The components  $R_1$  and  $R_2$ , and the trace connecting to the FB pin must NOT be adjacent to the LX net on the PCB layout to avoid the noise problem.

5) If the system chip interfacing with the EN pin has a high impedance state at shutdown mode and the IN pin is connected directly to a power source such as a Li-Ion battery, it is desirable to add a pull down 1Mohm resistor between the EN and GND pins to prevent the noise from falsely turning on the regulator at shutdown mode.



**AN\_SY8120B**

**SOT23-6L Package Outline & PCB layout**

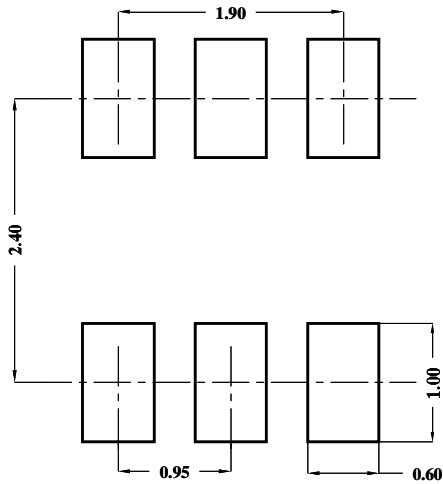

**Recommended Pad Layout**

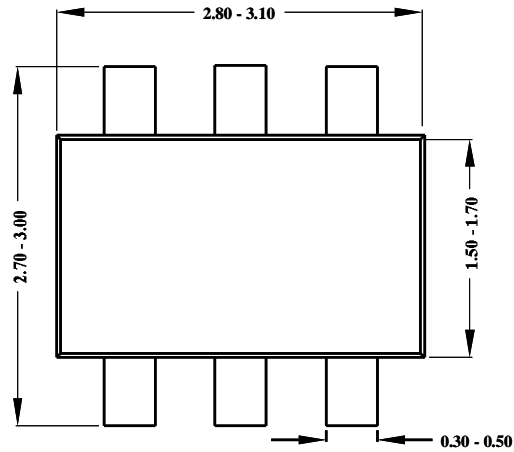

**Top View**

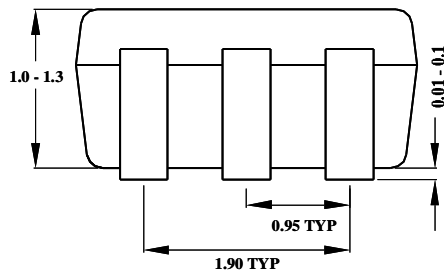
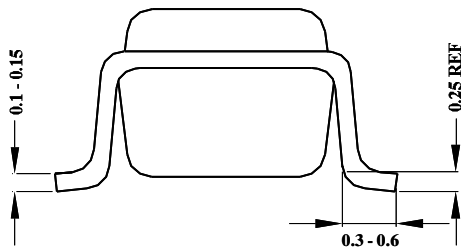

**Notes:** All dimension in MM  
 All dimension don't not include mold flash & metal burr





## AN\_SY8120B

### Taping & Reel Specification

#### 1. Taping orientation

SOT23-6

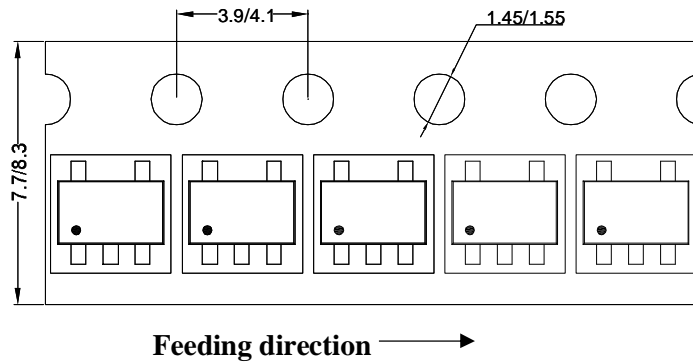

#### 2. Carrier Tape & Reel specification for packages

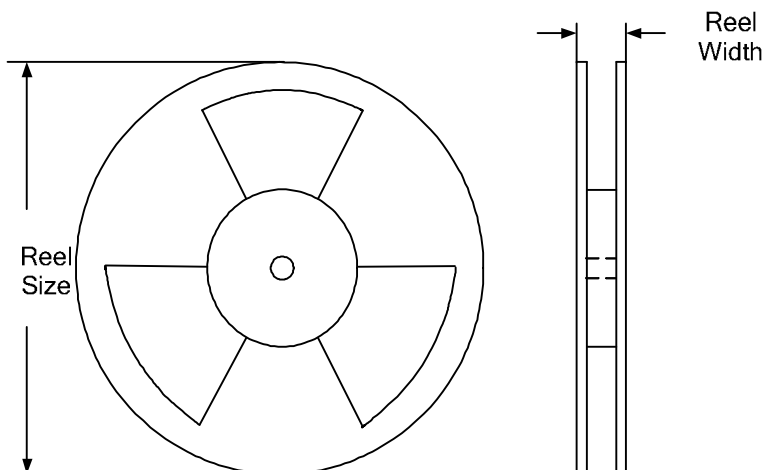

Package types	Tape width (mm)	Pocket pitch(mm)	Reel size (Inch)	Reel width(mm)	Trailer length(mm)	Leader length (mm)	Qty per reel
SOT23-6	8	4	7"	8.4	280	160	3000

#### 3. Others: NA